

Mercury Metal Skin™



info@ansutek.co.nz
www.ansutek.co.nz
www.ansutekbiz.co.nz

Functional Specifications

RF air protocol	EPC Class 1 Gen 2; ISO18000-6C
Operating frequency	UHF 860-960 MHz (Global)
IC type	Impinj Monza 4E ¹
Memory configuration	496 EPC bits, 128 bits user memory, 48-bit serialized TID
Functionality	Read / write (user programmed)

Performance Characteristics

Read range on metal (2W ERP) ²	Up to 13 ft (4 m)
Read range off metal (2W ERP) ²	Up to 16 ft (5 m)
Polarization	Linear

Smart Label Specifications

Dimensions / tolerance (mm)	101.6(+/- 1) x 38(+/- 0.8) x 0.76(+/- 0.1)
Dimensions / tolerance (in)	4(+/- 0.04) x 1.5(+/- 0.03) x 0.03(+/- 0.004)
Face material	White thermal transfer face stock
Background adhesive	High performance adhesive
Delivery format	On reel
Quantity per reel	500
Inner reel core diameter	3 in (76.2 mm)
Outer reel diameter	8 in (203 mm)
Weight (reel)	4.85 lbs (2.2 kg)



¹This product utilizes an Impinj M4E chip; each tag will have the exact same EPC number and a unique TID number. Xerify will verify the Read/Write function of each chip memory before shipment.

²Actual read range may vary based upon use case and antenna power.

Product Dimensions

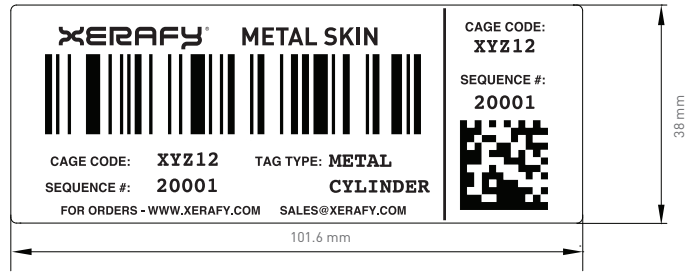

Product Reel Dimensions

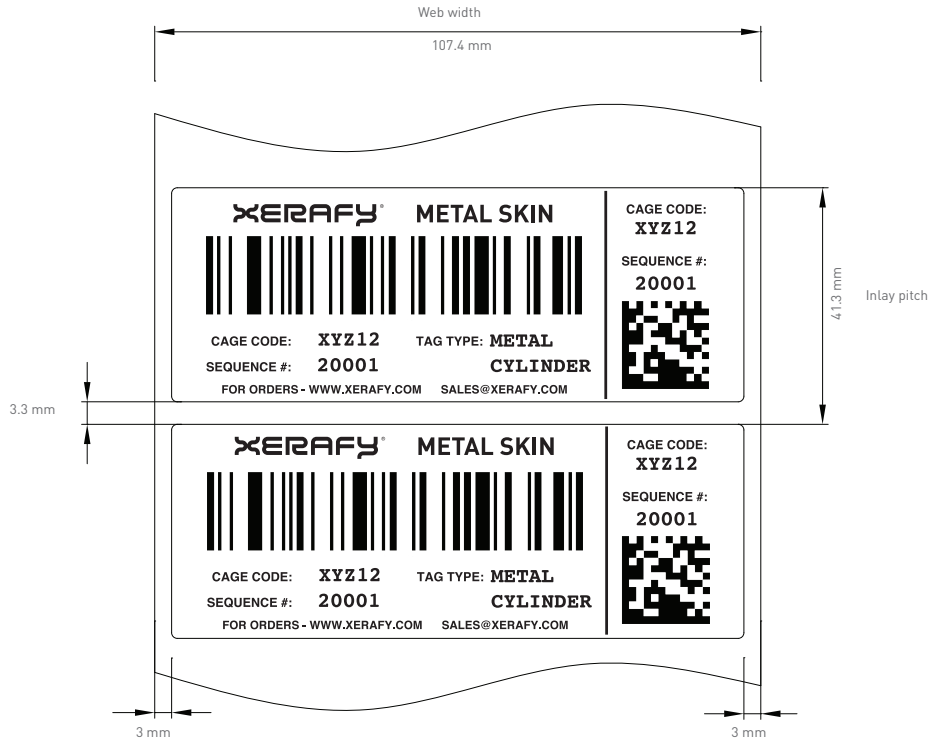

Smart Label Cross Section

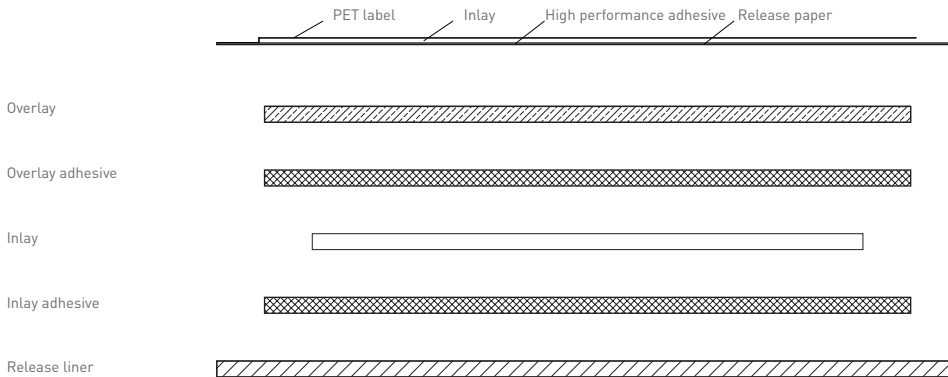

Printer Compatibility

Zebra	RZ400
SATO	CL4NX/GT412e
TOSHIBA	B-SX5T/SX4T

Radiation Pattern

On metal-Horizontal / Vertical

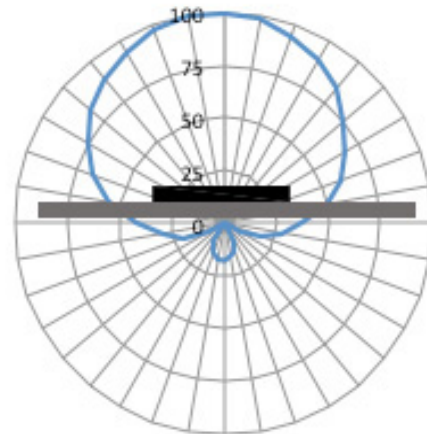
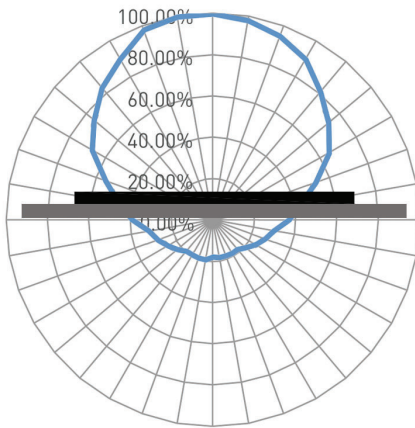

Off metal-Horizontal / Vertical

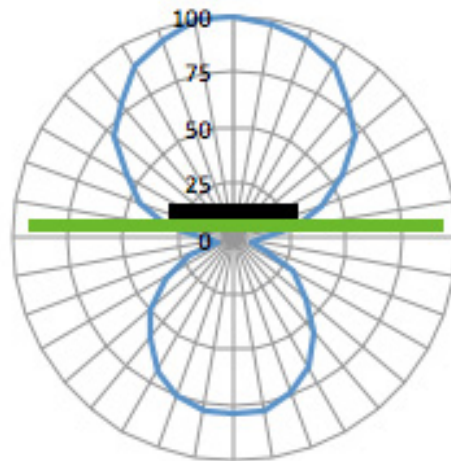
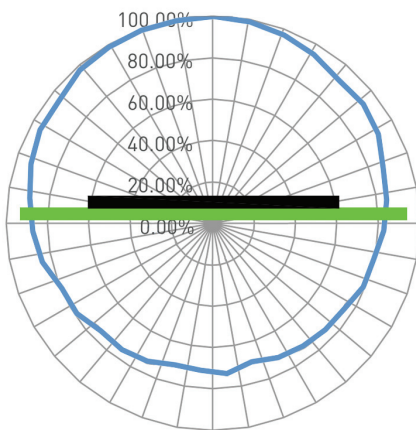

On Liquid-Horizontal / Vertical

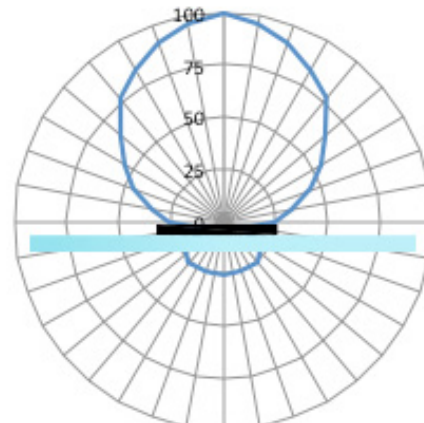
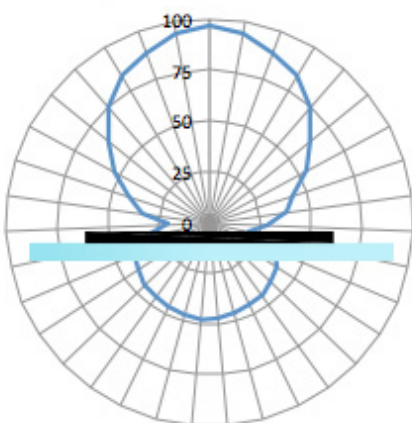

Operational and Environmental Specifications

Operational temperature	
Cold	-40°F (-40°C)
Dry heat	+185°F (+85°C)
Thermal shock	-40°F to 185°F (-40°C to +85°C); cycled
Application temperature	
Cold	-40°F (-40°C)
Dry heat	+185°F (+85°C)
Storage conditions	2 years at +68°F (+20°C) and 50% relative humidity
Shock (drop)	3 ft (1 m) to concrete/granite up to 100 cycles
Vibration	MIL-STD-810F
Compression strength	92 psi (634 kPa)
Compliance	RoHS, CE

Application Instructions

The Metal Skin can be applied directly onto metal surfaces. Its polarization is along the length of the label. For the purpose of determining a guideline, we've defined acceptable performance as 50 percent of the expected read distance. If the label is horizontally oriented, the minimum bending radius is 1.57 in (40 mm). If the label is vertically oriented, the minimum bending radius is 0.98 in (25 mm). Exceeding these recommended ranges will affect performance and may also physically damage the label, resulting in shortened life span.

The label should ideally be applied in the following conditions, 68°F (+20°C) and 50% relative humidity. For exceptional conditions, please contact Xerafy. The label adhesive will provide maximum adhesion 24 hours after application.

Horizontally oriented

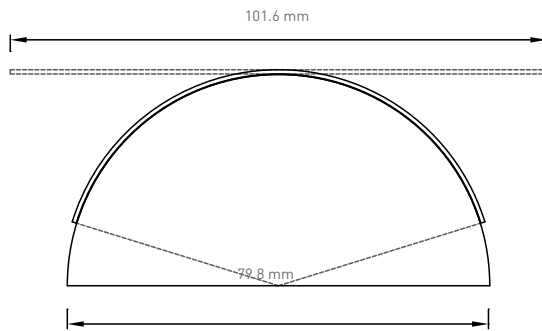

Vertically oriented

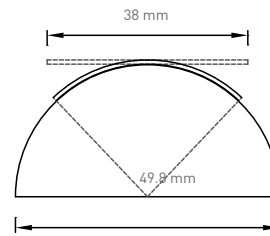

Read range

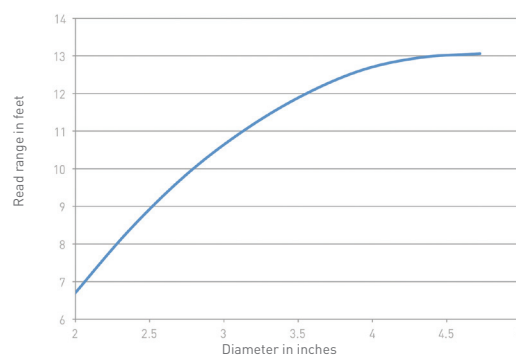
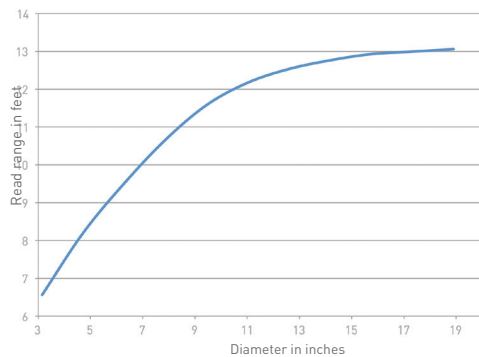

Order information

X50A0-GL000-M4

X50A0-GL100-M4

Mercury Metal Skin Dry Inlay in Roll

Mercury Metal Skin Label in Roll