

## Platinum Metal Skin™



### Functional Specifications

RF air protocol	EPC Class 1 Gen 2; ISO 18000-6C
Operating frequency	902-928 MHz (US), 865-868 MHz (EU)
IC type	Alien higgs4
Memory configuration	128 bits user memory, 128 bits EPC, 96 bits TID
Functionality	Read / write (user programmed)
Memory – expected read / write cycles	10,000 cycles at 77°F (25°C)
Data retention	Up to 10 years

### Performance Characteristics

Read range on metal (2W ERP)*	Up to 6.6 ft (2 m)
Read range off metal (2W ERP)*	Up to 3.9 ft (1.2 m)
Read range on liquid (2W ERP)*	Up to 3.9 ft (1.2 m)
Polarization	Linear

### Smart Label Specifications

Dimensions / tolerance (mm)	58 (+/- 0.5) x 19 (+/- 0.5) x 0.8 (+/- 0.1)
Dimensions / tolerance (in)	2.28 (+/- 0.02) x 0.75 (+/- 0.02) x 0.03 (+/- 0.004)
Pitch on reel	1.38 in (34.93 mm)
Quantity per reel	1000
Inner reel core diameter	3 in (76.2 mm)
Outer reel diameter	6 in (153 mm)
Weight (piece)	0.053 oz (1.5 g)
Weight (reel)	3.53 lbs (1.6 kg)



\*Actual read range may vary based upon use case and antenna power.

**Product Dimensions**

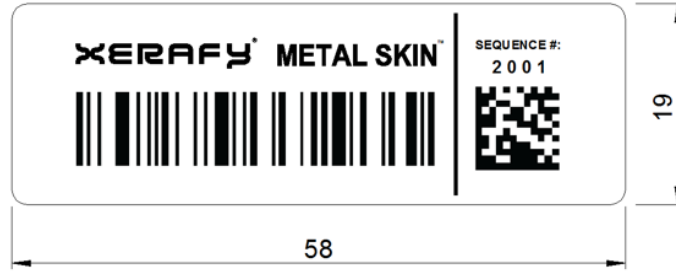

**Product Reel Dimensions**

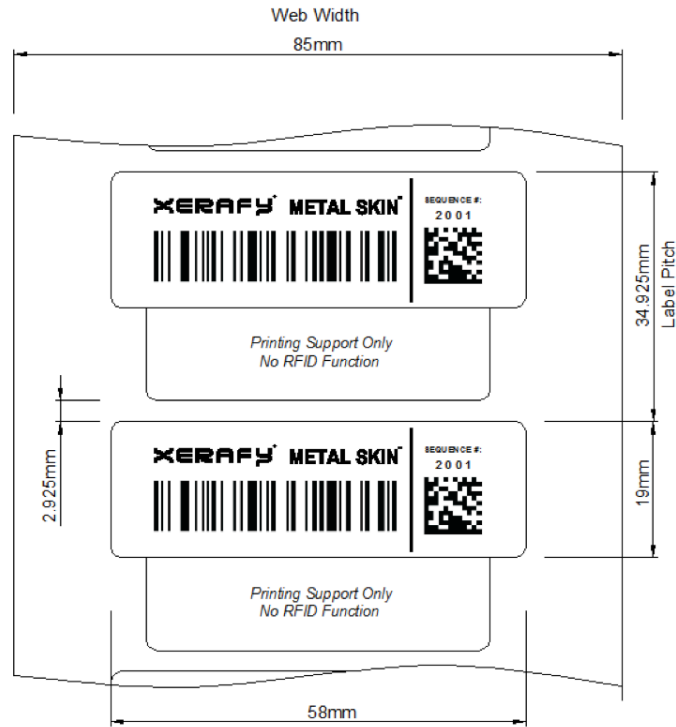

**Smart Label Cross Section**

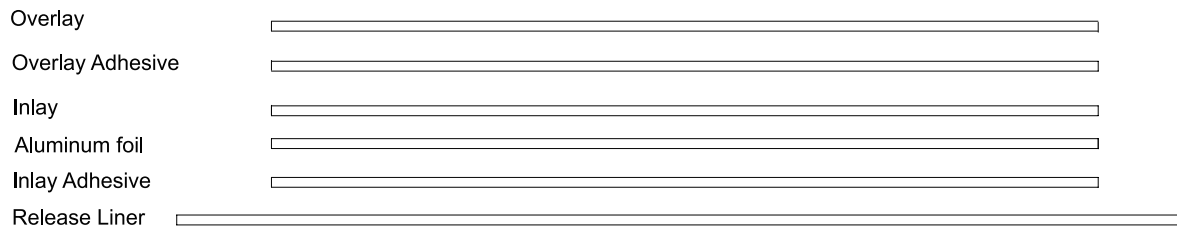

## Radiation Pattern

On metal

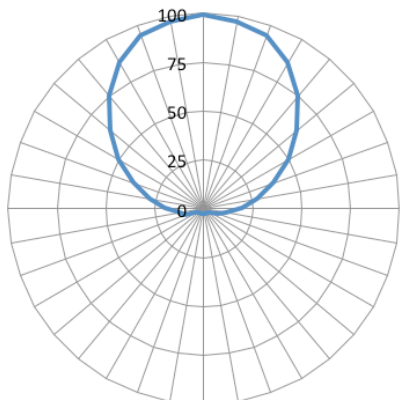

Horizontal

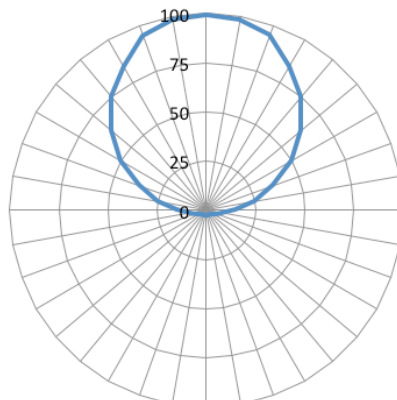

Vertical

Off metal

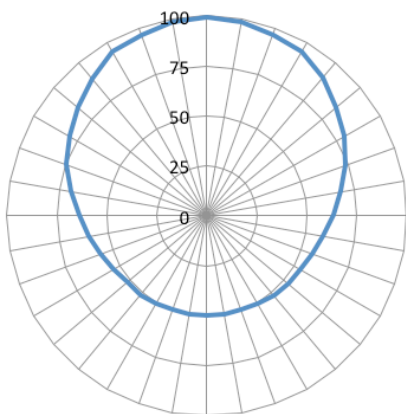

Horizontal

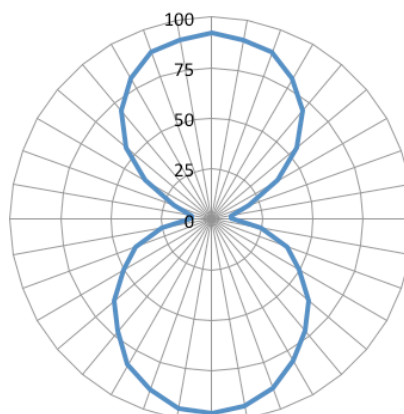

Vertical

On Liquid

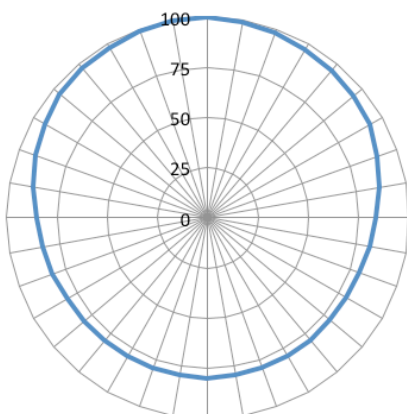

Horizontal

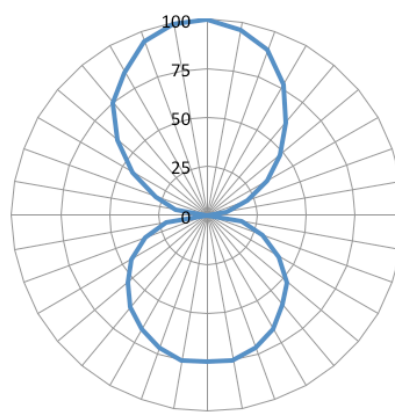

Vertical

## Operational and Environmental Specifications

Operational temperature	
Cold	-40°F (-40°C)
Dry heat	+185°F (+85°C)
Thermal shock	-40°F to 185°F (-40°C to +85°C); cycled
Application temperature	
Cold	-40°F (-40°C)
Dry heat	+185°F (+85°C)
Storage conditions	1 years at +68°F (+20°C) and 50% relative humidity
Shock (drop)	3 ft (1 m) to concrete/granite up to 200 cycles
Compression strength	14 psi (97 kPa)
Compliance	RoHS, CE

## Application Instructions

Tag performance when attached on curve surface:

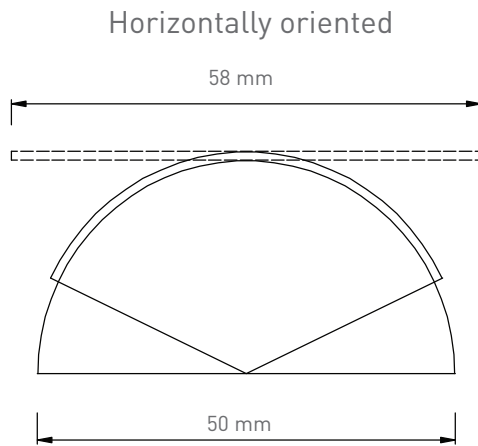

Read range on metal

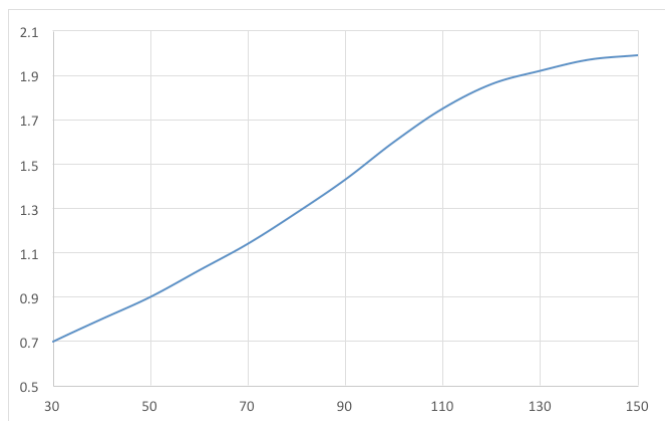

Read range off metal

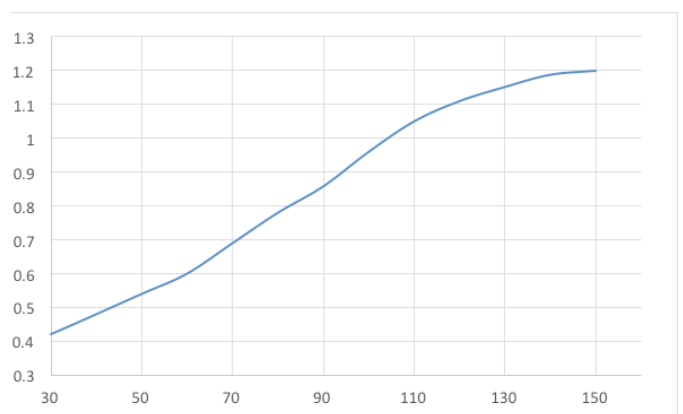

X: Diameter/mm Y: Read Range/ m

## Personalization options

Several options are available:

- Pre-encoding - Customer specific encoding of EPC or user memory.
- Customized printing - Customer specific layout including logo, text, numbers, barcodes etc.

## Printer Compatibility

Zebra	RZ400/R110Xi4
SATO	CL4NX/GT412e
TOSHIBA	B-SX5T/SX4T

## Order information

X50A1-US100-H4	Platinum Metal Skin Label in Roll US
X50A1-EU100-H4	Platinum Metal Skin Label in Roll EU



info@ansutek.co.nz  
www.ansutek.co.nz  
www.ansutekbiz.co.nz